

MIX1005/MIX1005A Combustible Gas Sensor

Version No.:1.5

Features:

- * High sensitivity to LPG and LNG
- * High sensitivity
- * Long life and low cost
- * High anti-seismic

Application:

- * Domestic gas leakage detectors
- * Portable gas detectors

The sensing material of MIX1005 is tin dioxide SnO_2 , which has low conductivity in clean air. When the combustible gas exists, the conductivity of the sensor will be raise according to the gas concentration goes up. Through a simple circuit, to convert the changes of conductivity to correspond to the gas concentration.

MIX1005 has high sensitivity to LPG (C_3H_8) the sensor can work in high temperature. It is low cost sensor and can be used in different applications.



Structure and Dimensions:

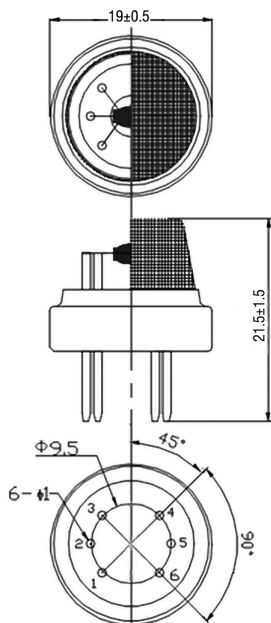

Test Circuit:

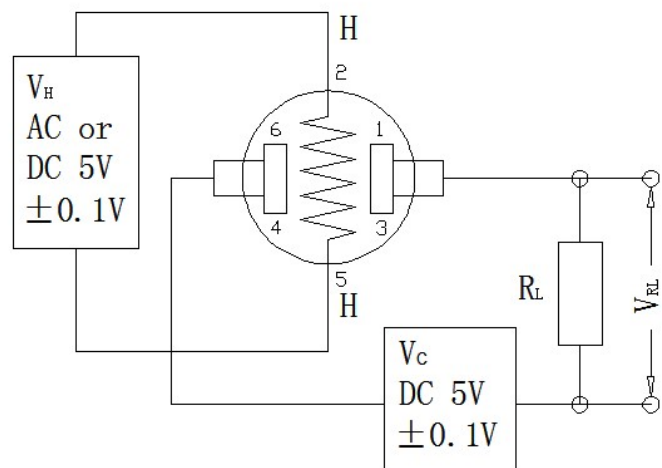

Specification:

Item	Specification
Target Gas	Combustible gas, LPG
Measurement Range	300~10000ppm(C ₃ H ₈ , CH ₄)
Heater Voltage(V _h)	5.0V±0.1V AC or DC
Loop Voltage	≤24V DC
Heater Resistance(R _h)	29Ω±3Ω(Room temperature)
Heater Power Consumption(P _h)	≤950mW
Sensitivity	R _s (in air)/R _s (2000ppm C ₃ H ₈)≥ 5
Concentration Slope(α)	≤0.6(R _{3000ppm} /R _{1000ppm} C ₃ H ₈)
Output In Target Gas	2.5~4.0V(2000ppm C ₃ H ₈)
Testing Condition	20°C±2°C; 55%±5%RH 21%, no less than 18%
Oxygen concentration in used place	If used in low oxygen concentration, please contact for detail
Life Expectancy	10 years

Sensitivity Characteristics:

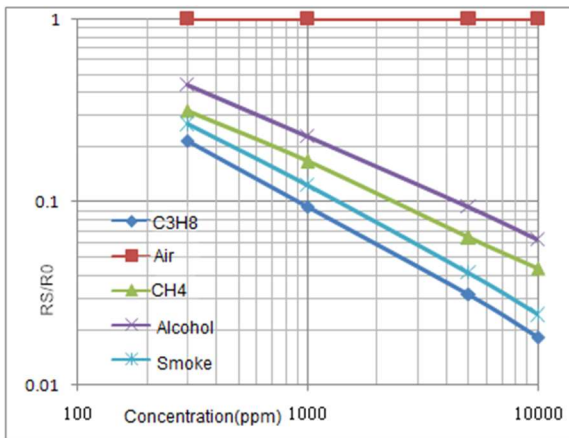

Linear Diagram:

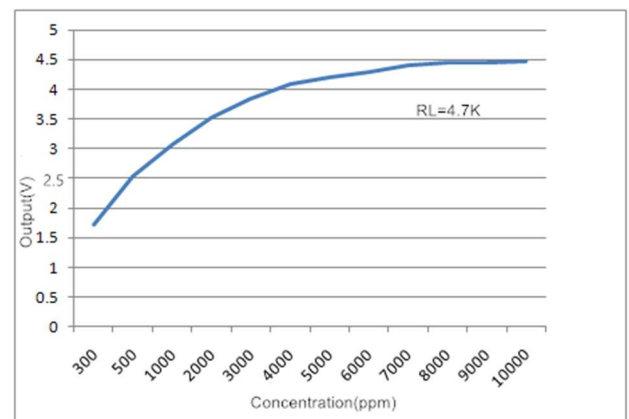

Temp. & hum. Characteristics

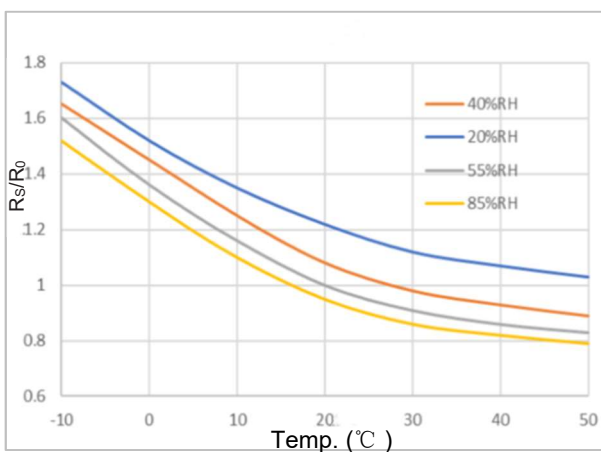

Response and Recovery

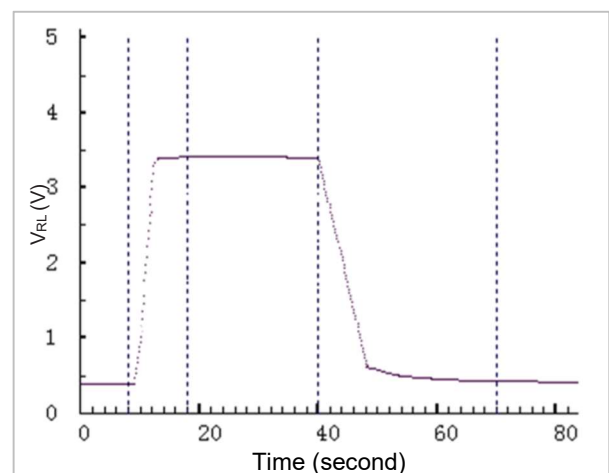

Long-term Stability:

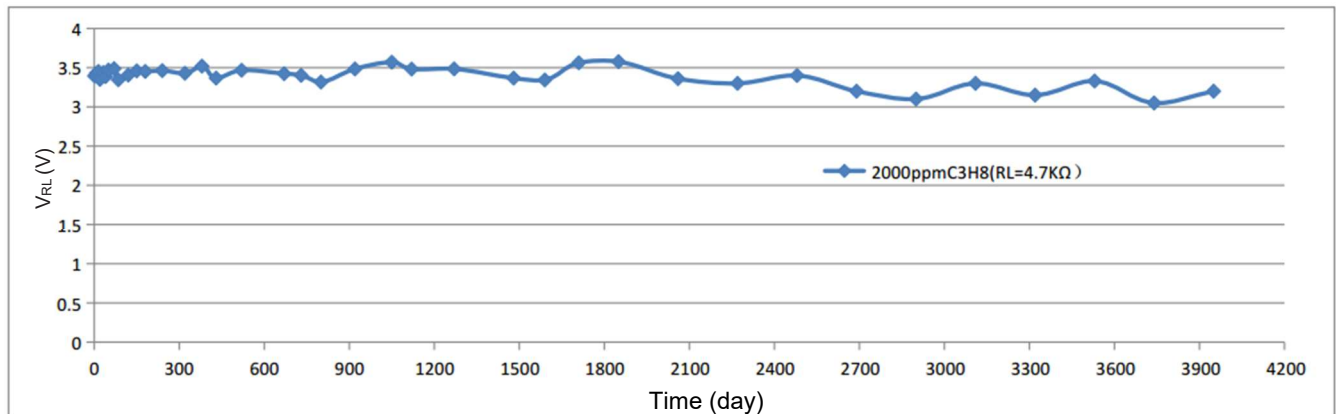

Cautions:

1. Forbidden exposed the sensor in the organic silicon steam. Sensing material will lose sensitivity and never recover if the sensor absorbs organic silicon steam. The sensor must avoid exposing to silicon bond, fixture, and silicon latex, putty or plastic contain silicon environment.
2. Forbidden exposed the sensor in high corrosive gas. If the sensor was exposed to high concentration corrosive gas (e.g. H_2S , SO_x , Cl_2 , HCl etc.), it will not only result in corrosion of sensor's structure, also it cause sincere sensitivity attenuation.
3. Forbidden contact to Alkali, Alkali metals salt, halogen pollution. The performance will be changed badly if sensor was polluted by alkali metals salt especially brine, or be exposed to halogen e.g. fluorine.
4. No-contact with the water. No icing on the surface of the sensor.
5. Don't apply with high voltage. When the sensor applied voltage cannot be higher than stipulated value, even if the sensor is not physically damaged or broken, it causes down-line or heater damaged, and bring on sensors' sensitivity characteristic changed badly.
6. Forbidden supply wrong voltage in different pins. Only for 6 pins sensor. Pin 2&5 is heating electrodes, Pin (1,3)/(4,6) are testing electrodes (Pin 1 connects with Pin 3, while Pin 4 connects with Pin 6). If apply voltage on Pin 1&3 or 4&6, it will make lead broken; and no signal putout if apply on pins 2&4.

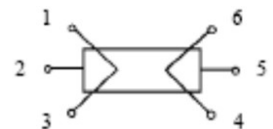

7. Avoid condensation water on the surface of the sensor. Indoor conditions, slight condensation water will influence sensors' performance lightly. However, if condensation water on sensors surface and keep a certain period, sensors' sensitive will be decreased.
8. Avoid using the sensor in high gas concentration. No matter the sensor is electrified or not, if it is placed in high gas concentration for long time, sensors characteristic will be affected. If lighter gas sprays the sensor, it will cause extremely damage.
9. Avoid store the sensor for long time. The sensor's resistance will drift reversibly if it's stored for long time without electrify, this drift is related with storage conditions. Sensor should be stored in airproof bag without volatile silicon compound. For the sensor with long time storage but no electrify, they need long aging time for stability before using. The suggested aging time as follow:

Storage time	Recommend aging time
Less than 1 month	No less than 48 hours
1~6 months	No less than 72 hours
Over 6 months	No less than 168 hours

10. Avoid exposed the sensor in adverse environment for long time. No matter the sensor electrified or not, if exposed to in adverse environment for long time, e.g. high humidity, high temperature, high pollution etc., it will influence the sensors' performance badly.
11. Avoid vibration and concussion the sensor. If continual vibration the sensors, the down-lead will be break. In transportation or assembling line, pneumatic screwdriver/ultrasonic welding machine can lead this vibration. If concussion the sensor badly, the lead wire will disconnected.
12. Operate the sensor under following condition:

a. Handmade soldering conditions:

Item	Condition
Soldering Flux	Less chlorine
Seaming Iron	Constant temperature
Temperature Of Seaming Iron	250°C
Time Of Soldering	Less than 3 seconds

b. Wave-soldering conditions:

Note: Getting through the soldering machine by once

Item	Condition
Soldering Flux	Less chlorine
Speed	1-2 meter/ minute
Warm-Up Temperature	100±20°C
Soldering Temperature	250±10°C

If does not following above operation terms, the sensor's sensitivity will be decreased.

Shenzhen Mixsen Electronics Co., Ltd
 Add.: 4A, No. B Building, Dalangyongtai Industrial Park, Huawang Road, Longhua District, Shenzhen, Guangdong, China
 Post: 518000
 Tel: 86-755-86635585
 Mail: sales@mixsen.com
 Website: www.mixsensors.com